



# Installation & Operation Manual

## All-in-One Heat Pump Water Heater

Model:

EPG-200AC

EPG-270AC



## **Table of Contents**

<b>1. Safety Precautions .....</b>	<b>- 1 -</b>
<b>2. General Information .....</b>	<b>- 5 -</b>
<b>3. Parts and Components .....</b>	<b>- 8 -</b>
<b>4. Installation .....</b>	<b>- 10 -</b>
<b>5. Plumbing Connections .....</b>	<b>- 14 -</b>
<b>6. Electrical Connections .....</b>	<b>- 18 -</b>
<b>7. Controller Instruction .....</b>	<b>- 20 -</b>
<b>8. Commissioning .....</b>	<b>- 29 -</b>
<b>9. Maintenance and Solution .....</b>	<b>- 30 -</b>
<b>10. Warranty .....</b>	<b>- 32 -</b>

# 1. Safety Precautions

**Before attempting to install this unit please ensure you have read the safety precautions and fully understand them. This product must only be installed by qualified personnel in the mechanical and electrical industry.**

## Warning



1.1. This appliance must be installed, commissioned, and serviced by an authorized person in accordance with all applicable national/local rules and regulations which include:

- a. AS/NZS 3500.4 – Plumbing and drainage Heated water services
- b. AS/NZS 3000 – Electrical installation
- c. AS/NZS 2712.2007 – Solar and Heat Pump Water Heaters: Design and Construction
- d. AS/NZS AS 3498—2009 – Water heaters and hot-water storage tanks
- e. The power cord chosen must be compliant with AS/NZS 3191 and the nominal cross-sectional area should be 1.5 mm<sup>2</sup> or more and should handle at least 15A (2 core and earth)
- f. Plumbing Regulations 2008

1.2. Warning: for continued safety of this appliance it must be installed, operated and maintained in accordance with the manufacturer's instructions

1.3. Warning: appliance not limited to 45°C or 50°C: Warning: This Appliance may deliver water at high temperature refer to the plumbing code of Australia (PCA), local requirements and installation instructions to determine if additional delivery temperature control is required.

1.4. Household electrics must have a reliable earth connection.

1.5. This product must be protected with a residual current device of adequate rating.

1.6. Do not interfere with any permanent instruction, labels or warning plate attached to the external cover of this heat pump.

1.7. This product must only be installed by qualified personnel in the plumbing and electrical industry.

1.8. Always comply with local wiring regulations.

1.9. Maintenance and repair work must only be undertaken by trained and qualified personnel.

1.10. The electrical connection to this product must be via a 15A RCD/MCB or RCBO with a test button function.

1.11. The final electrical connection must be via a double pole isolating switch located close to the unit. The isolating switch must never be covered up.

1.12. A One way isolating valve must be installed on the cold water supply pipe for maintenance purposes.

1.13. This appliance should never be used by children.

1.14. If the power supply cord is damaged, it must be replaced by the

manufacturer, its service agent or similarly qualified personnel in order to avoid a hazard.

1.15. Do not operate this heat pump in a wet room such as a bathroom or unless it is housed in a separate cupboard within that room.

1.16. The heat pump not equipped with plug, shall be installed outdoor with an isolation switch connected.

1.17. If the hot water system is not used for two weeks or more, a quantity of highly flammable hydrogen gas may accumulate in the water heater. To dissipate this gas safely, it is recommended that a hot tap be turned on for several minutes or until discharge of gas ceases. Use a sink, basin, or bath outlet, but not a dishwasher, clothes washer, or other appliance. during this procedure, there must be no smoking, open flame, or any electrical appliance operating nearby. If hydrogen is discharged through the tap, it will probably make an unusual sound as with air escaping.

## R290 Warning



- This appliance uses R290 (propane) refrigerant, which is a flammable gas and must be serviced by an authorized person.
- WARNING Risk of fire/flammable material. If the refrigerant is leaking, switch off the unit at the mains and contact the service agent.
- DO NOT store chemicals or flammable materials near this appliance.
- NEVER use a flammable spray such as hair spray, paint, etc near this unit as this may cause a fire.
- Avoid risk of injury from contact with refrigerant if you notice a leak.
- If you suspect the refrigerant is leaking then:  
Do not smoke.  
Do not operate electrical equipment. Isolate the device.
- End of life recycling, the refrigerant must not enter the atmosphere. Only have the refrigerant removed by qualified professional.
- The heat pump is designed for external installation only. Where a system has been installed internally or in an unventilated room, the following parameters must be observed so that should any refrigerant leak, it will not stagnate so as to create a fire or explosion hazard.
- MINIMUM FLOOR AREA = 45m<sup>3</sup>
- based off a charge of 0.350Kg and allowable piratical limit for R290 of 008Kg/m<sup>3</sup>.

## 2. General Information

### 2.1. Features

- a. All in one Heat Pump Hot Water:
- b. Quality built enamel water cylinder
- c. Quality highly efficiency micro-channel heat exchanger wrapped in close contact for thermal conductivity



- d. No contact between the refrigerant piping and the water for additional safety.
- e. The maximum outlet water temperature is 75°C with using a combination of the heat pump and auxiliary heating element. For efficient heating using the heat pump only it is recommended that the hot water temperature limit is set for 55°C.

## 2.2. Refrigerant circuit

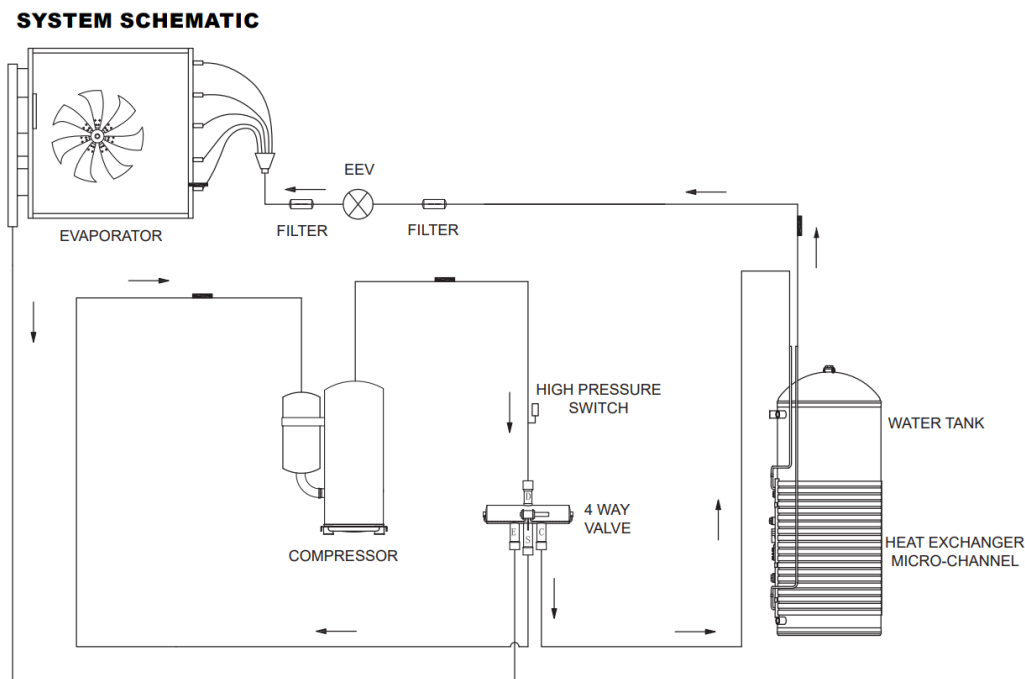

Compressor: GMCC - R290

Evaporator: Copper tube and aluminum fin type heat ex-changer.

Fan: Axial type;

Tank: Enamel water tank

Heat exchanger: Micro-channel wrap around water tank with high efficiency.

Controller: Touch screen



### 2.3. Specifications

Model No.	EPG-200AC	EPG-270AC
Heating Capacity at Air 20°C /15°C, Water Temperature from 15°C to 55°C		
Heating Capacity(kW)	2.78	2.78
Power Input(kW)	1.2	1.2
COP	4.15	4.15
Power Supply	220V~240V/50Hz	220V~240V/50Hz
Heat Pump Max Power Input(W)	3000	3000
Heat Pump Max Current(A)	5.3	5.3
Electric Heater(W)	1800	1800
Electric Heater Current(A)	7.5	7.5
Refrigerant	R290/400g	R290/400g
Net Dimension(mm)	Φ626×1565	Φ626×1880
Package Dimension(mm)	700×700×1667 (with pallet)	700×700×1982 (with pallet)
Net Weight(Kg)	104	118
Gross Weight(Kg)	115	130
Noise(dB)	43	43
Water tank volume(L)	200	270
Working temperature range(°C)	-7~43	-7~43

# 3. Parts and Components

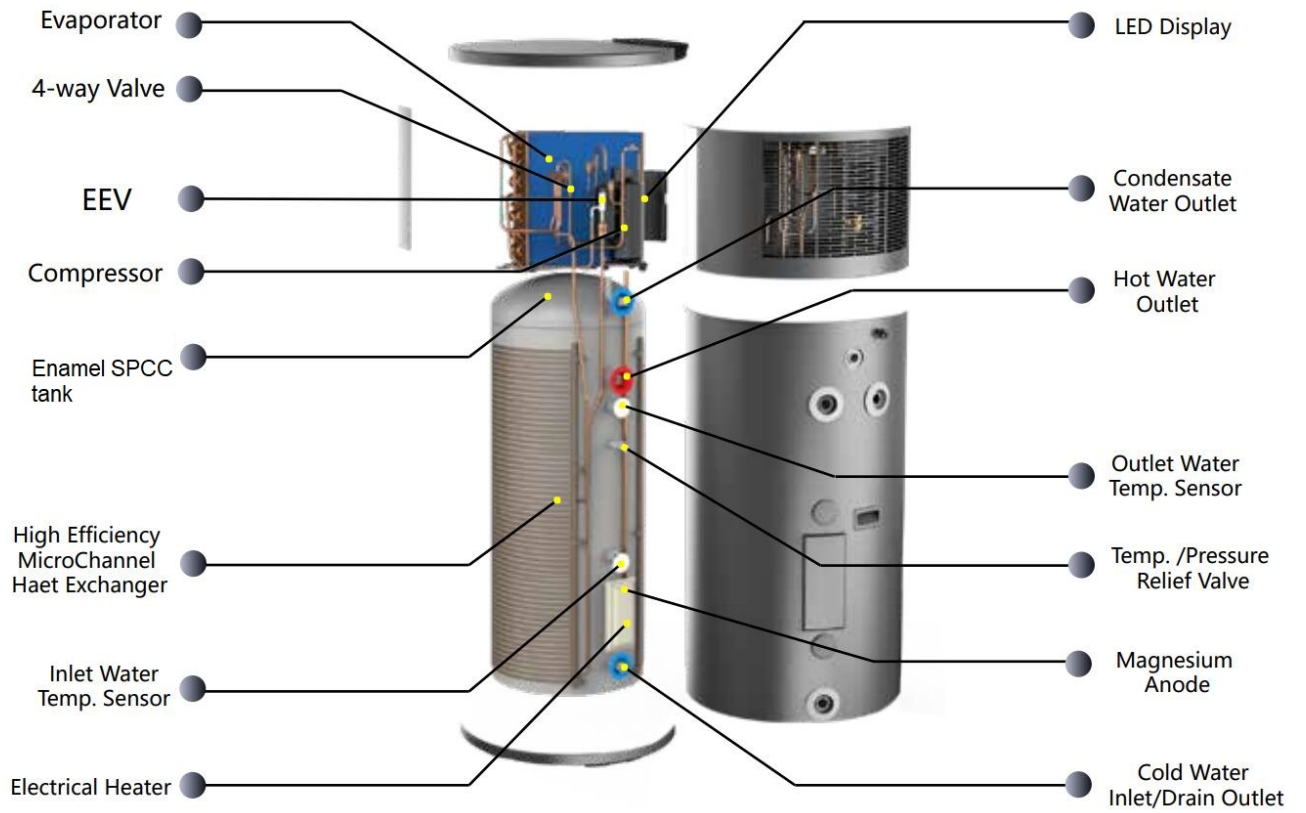

**NOTE:**

**All the pictures in this manual are for illustration purposes only. Please refer to local wiring and plumbing regulations. If in doubt of anything in this manual, contact your local service agent.**

**Products External Dimension**

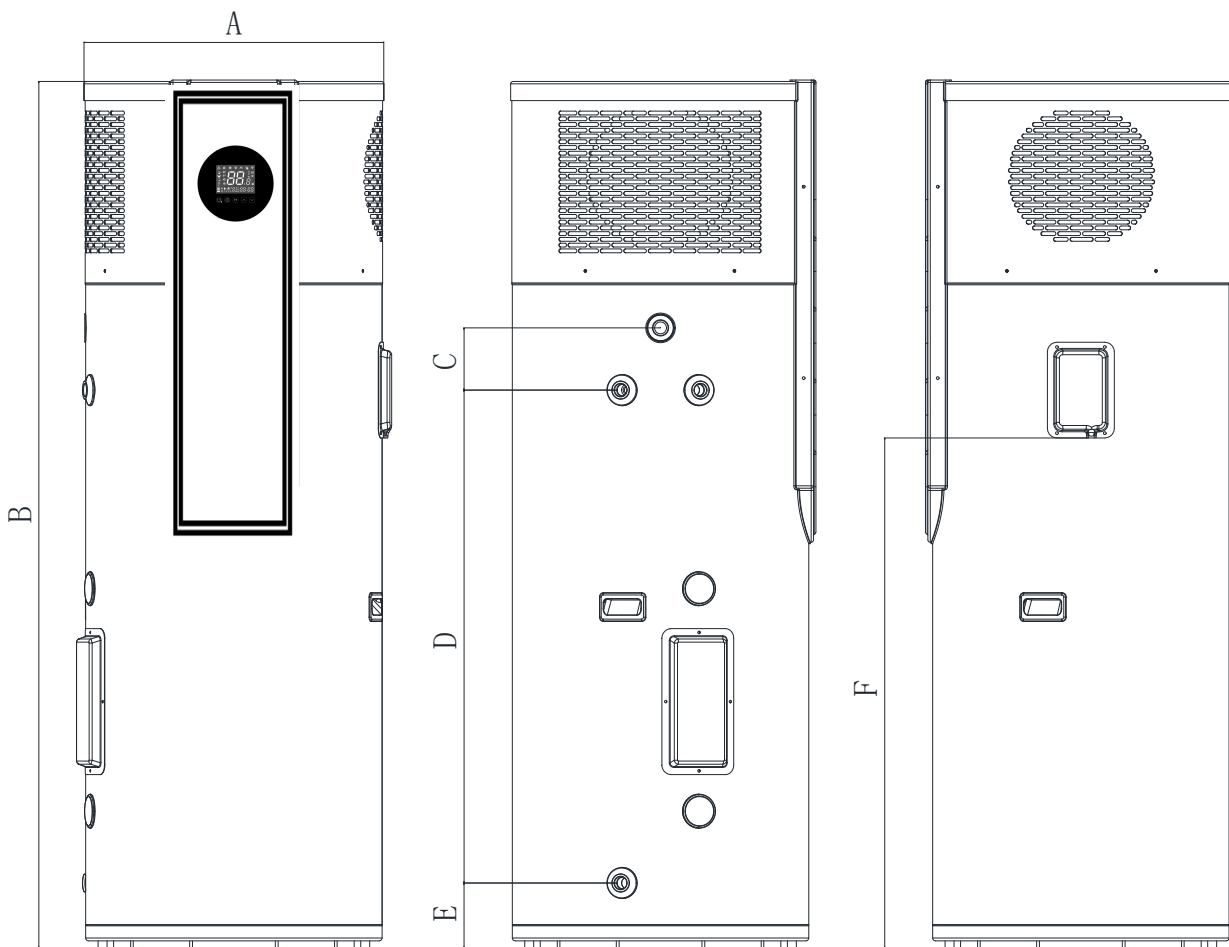

Model	Size(mm)	A	B	C	D	E	F
	EPG-200AC		626	1565	130	802	136
EPG-270AC		626	1880	130	1029	136	1066

## 4. Installation

### 4.1. Choose a suitable location

- a. Do not install this equipment indoor. If installed indoor, may cause overflow, noise or indoor temperature drop which can influence your normal life, please use preventive measures in advance;
- b. The placement must have enough space for installation and maintenance;
- c. Fan inlet or outlet must have no obstruction and keep strong wind off;
- d. Ventilated place is suitable;
- e. Supported surface must be flat (horizontal angle must not be more than  $2^\circ$ ), and can bear heat pump's weight and easy to install vertically
- f. The noise and exhausting air don't create nuisance to neighbors' normal life;
- g. The location has free ventilation;

#### **h. NOTE**

**If the product is installed in a location where there is a possibility of frost, then all precautions must be taken to ensure all pipework is sufficiently insulated.**

#### **i. NOTE**

**The following locations are not recommended as suitable installation locations of the product: Areas containing toxic gases or mineral oils.**

### 4.2. Transporting the product.

- a. This heat pump is heavy and requires at least two people to lift it with the assistance of lifting equipment.
- b. It is always recommended to lift the product with all its packaging in place.
- c. Always wear PPE when lifting the product.
- d. Do not move the heat pump at the angle more than  $45^\circ$
- e. Please note the outer casing of the unit is susceptible to denting and damage. Care and consideration should be taken into account when moving the unit as any marks caused by inappropriate handling are not deemed as defects and are not covered under warranty.

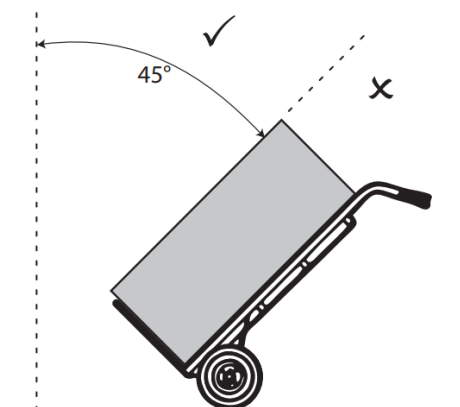

Never tilt unit more than  $45^\circ$  from vertical

### 4.3. The Installation of Heat Pump

#### a. Base

- The unit should be installed on a concrete plinth or stable structure capable of sustaining weights in excess of 400kg. The supporting structure must not shift over time (due to water drainage etc.). A concrete base of at least 50mm. Concrete base paver is being used, a minimum dimension of 600mm x 600mm is required.
- Please ensure that all four feet are supported by the base being used otherwise warranties may be voided.
- Proper drainage should be observed for any overflow in accordance with AS/NZS 3500.4
- After installation the unit must be completely vertical and level as to ensure that condensate can be properly drained. If the system is installed at a level with a tilt of more than 3 degrees, warranties may be voided.
- If property damage is likely to occur due to water leakage, a safe tray (overflow tray) must be installed.

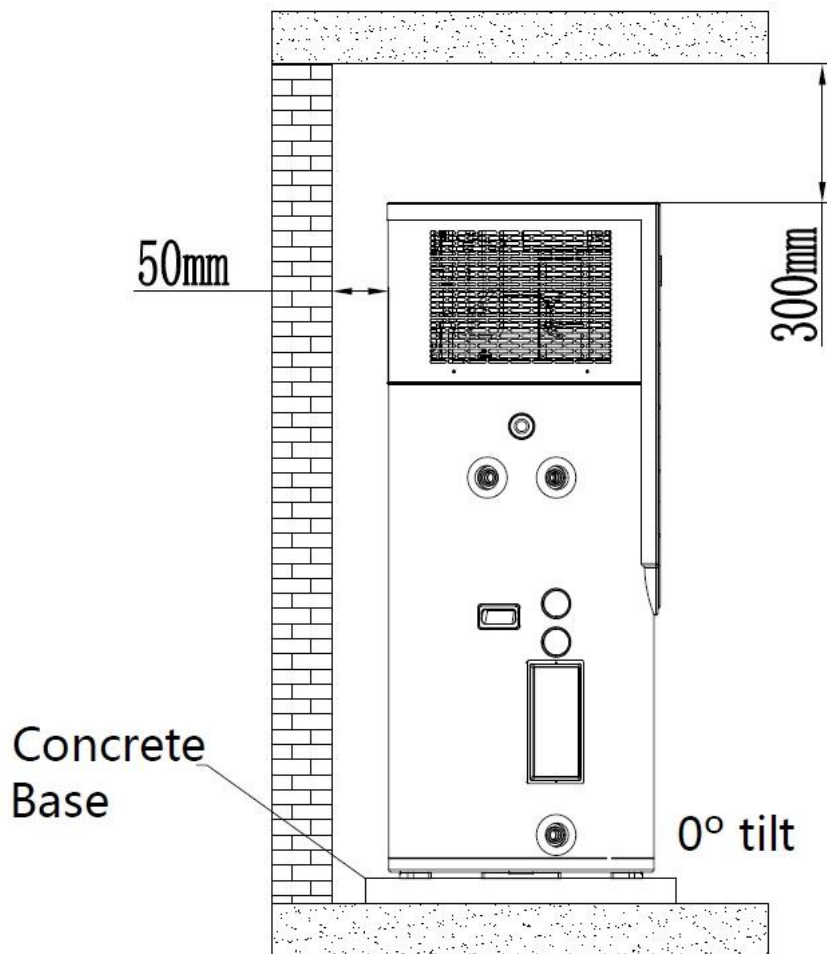

b. Air Flow

- This unit is designed for external operation only and requires a free flow of air to operate efficiently.
- Avoid installation in areas where falling debris such as leaves is prevalent as this may result in air vents being blocked or the unit being damaged.
- Avoid placing the system in locations with multiple walls or structures
- Always maintain optimum clearances from all structures
- If installed under fixtures or home eaves, there must be a minimum 300mm clearance between the top of the unit, 600mm on the right hand side of the system

(when facing unit) and 200mm on the left hand side of the system (when facing system). The unit must be installed with a minimum of 50mm off the rear wall so that the entire unit can be accessed during any servicing work as well as preventing cumulation of cold air. If the system cannot be properly serviced due to the system being installed outside of these specifications, the owner will be liable for the associated plumbing costs of draining and moving the system.

- The unit should be installed so that the control interface is accessible to users and that there is clear access to the electrical panel at the back of the system. Where incorrect installation has occurred warranties may be void or additional charges may be required to ensure that the system is compliant.

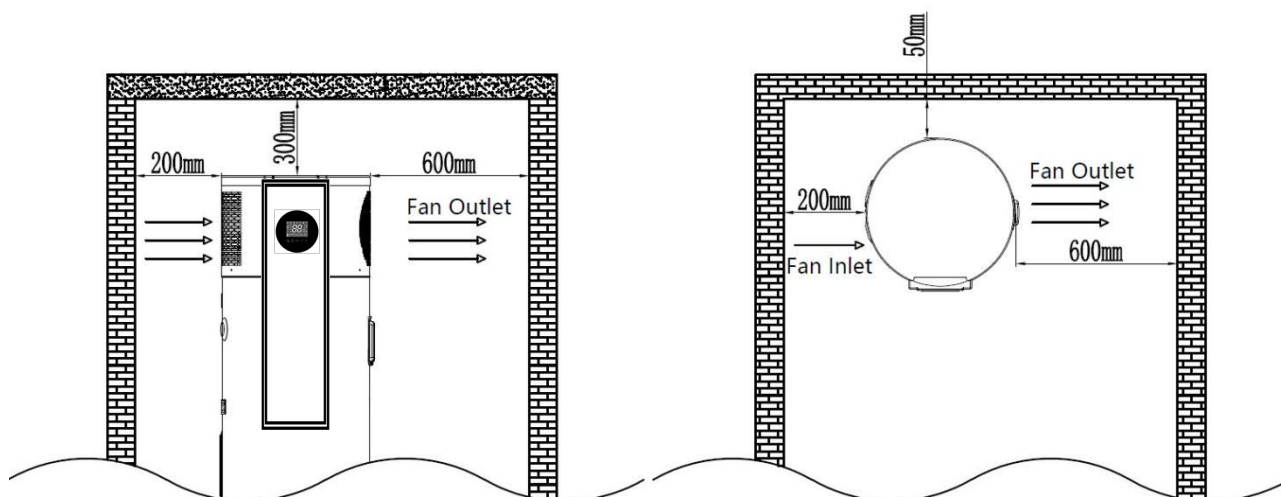

## 5.Plumbing Connections

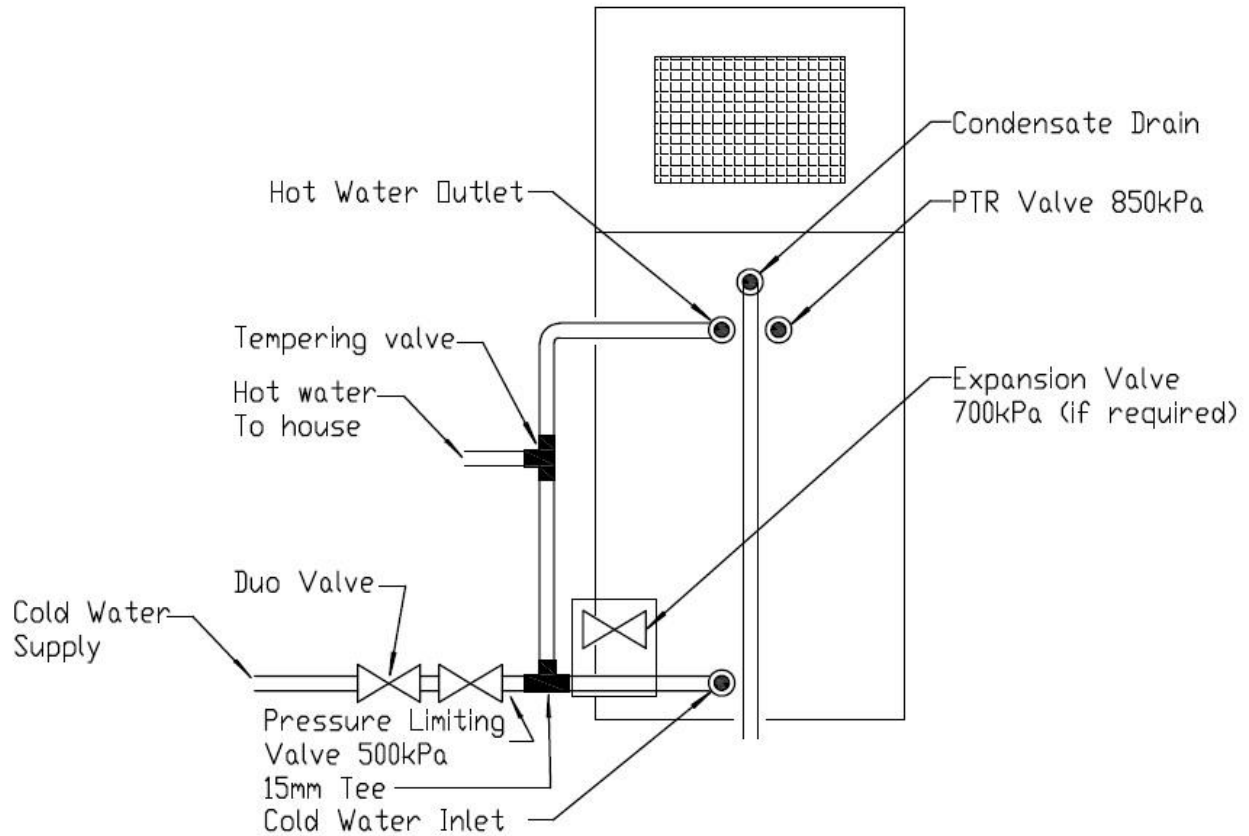

### 5.1. Plumbing Connection Diagram

The plumbing of system is shown above.

- The water inlet/outlet port connections are at G 3/4”
- All pipework must be sufficiently insulated with a minimum 13 mm closed cell insulation that is UV rated.
- The process of heat extraction from the atmosphere through evaporator coils results in the production of water in the form of condensation. To collect this water by-product a Condensate Tray is located on top of the water storage tank. Overflow



from this tray runs out through the Condensate Drain. The system's condensate drain is connected by a 1/2-inch copper elbow. Drain the condensate from the elbow to the nearest storm water via PVC piping. If not drained properly, the condensate line may become blocked as well produce algae and moss growth.

The Condensate line should be free of kinks and as the water is gravity fed, this should be installed vertical or with fall to ensure the free flow of water. Connecting any other pipe directly to the condensate line without an air gap will void warranties.

- Ensure the drain is clear of any block gas.
- The minimum cold-water pressure must be 200 kPa
- During operation and heat pump cycle, there will be condensation droplets forming within the heat pump. Always ensure the condensate pipe is connected to the drainage network or run to ground.
- Pressure and Temperature Relief Valve (PTR valve)

A PTR valve rated to 850kPa and 99°C is supplied with the system, and is to be fitted to the tank. It is recommended that the lever on pressure & temperature relief valve (PTR) be operated once every 6 months to ensure reliable operation. It is important to raise and lower the lever gently and be careful as the water released will be hot.

**DANGER:** Failure to operate the relief valve easing gear at least once every six months may result in the water heater exploding. Continuous leakage of water from the valve may indicate a problem with the valve, or the water heater itself.

Also ensure that the PTR valve and discharge point is installed in line with local plumbing regulations. Ensure PTR line is not discharged where it can cause damage or be of a nuisance.

- Pressure Limiting Valve

Where the mains water supply pressure is likely to exceed 550kPa at any time, a 500kPa pressure limiting valve that complies with AS1357 must be fitted to the inlet of the hot water system.

This is essential to safeguard the appliance and ensure correct operation

- Tempering valve

To reduce the risk of scalding injury a temperature control (tempering) valve must be fitted to the hot water supply pipe work. This valve should be checked at regular intervals to ensure its operation and settings remain correct.

**WARNING: SCALDING OCCURS AT 50°C. THIS APPLIANCE IS CAPABLE OF PRODUCING HOT WATER AT WELL ABOVE 50°C. A TEMPERING VALVE MUST BE INSTALLED AS PER YOUR LOCAL GOVERNMENT AND REGULATORY REQUIREMENTS.**

- Expansion control valve

The local requirements must be checked with the installer to see if this is required as part of the installation. This should be rated no more than 700 kPa.

- Non return isolation valve

It is regulated that this is installed to allow the hot water system to be isolated from the rest of the homes water supply, making servicing, draining and replacing the unit easy.

## **Filling and commissioning the Hot Water System**

1. Turn on the cold water supply to the tank and open a hot water tap preferably laundry tap without filter as existing sediment may partially block pre-existing water saving devices.
2. Leave tap open until all air is bled, then turn off hot water tap.
3. Activate PTR Valve (Pressure relief valve) to ensure system is fully bled of all air.
4. Once the system is fully pressurised with water, thoroughly check all fittings, connections and pipework for water leaks.

**NEVER OPERATE THIS UNIT IF THERE IS NO WATER IN THE TANK.  
THIS WILL RESULT IN POSSIBLE DAMAGE TO THE DRY RESISTIVE.**

## 6. Electrical Connections

6.1. The electrical connections must be completed by a qualified and trained professional and in accordance with the local and national regulations AS3000.

- This product must be wired on a dedicated circuit protected by a 15A circuit breaker
- The circuit must be connected to a reliable earth electrode connected to the unit
- The testing of the circuit and final connections are the responsibility of the trained installer

### 6.2. Power Specification

Item Model	Power supply	Cable Size (mm <sup>2</sup> )		Protection Device RCBO Type (B)		Earth Leakage
EPG-200AC EPG-270AC	220V/50Hz	L&N Conductors	PE Conductor	Rating (A)	TYPE	30mA
		Φ 2.5mm	Φ2.5mm	15	B	

**Note: Final connection is via a 15A isolating switch in close proximity to the heat pump**

- The unit is not supplied with a 3-pin plug.
- Instead of using a 3-pin plug, hard wiring of system to a 15A isolator switch is highly recommended.
- Before any work can commence ensure that the heater is isolated from the

power supply at the switchboard.

- If a power cable is damaged, it shall be replaced by a qualified professional to avoid risks

### 6.3. Wiring diagram

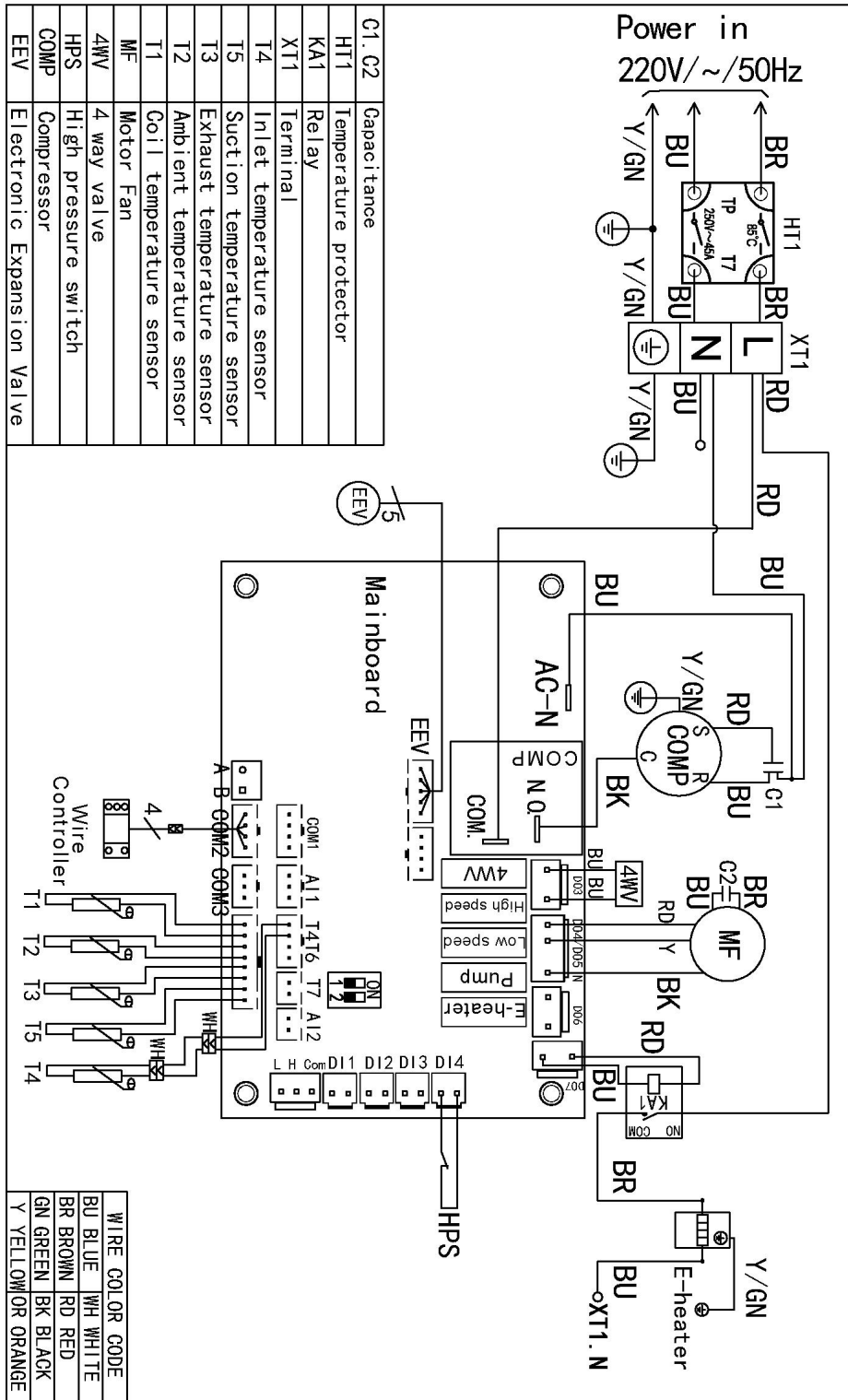

# 7. Controller Instruction

## 7.1. Features

### a. Operating condition

- Voltage: 220V $\sim\pm 10\%$ , 50Hz $\pm 1$ Hz.
- Ambient temperature: -7 $\sim$ +43 $^{\circ}$ C
- Storage temperature: -20 $\sim$ +70 $^{\circ}$ C
- Relative humidity: 0 $\sim$ 95%RH
- Temperature accuracy:  $\pm 1^{\circ}$ C
- The tanks comply with legionella by heating 45% of the tank to 60degC each day.
- This is ensured by having the set point at 60degC and having a low dead band (3k).



### b. Main function



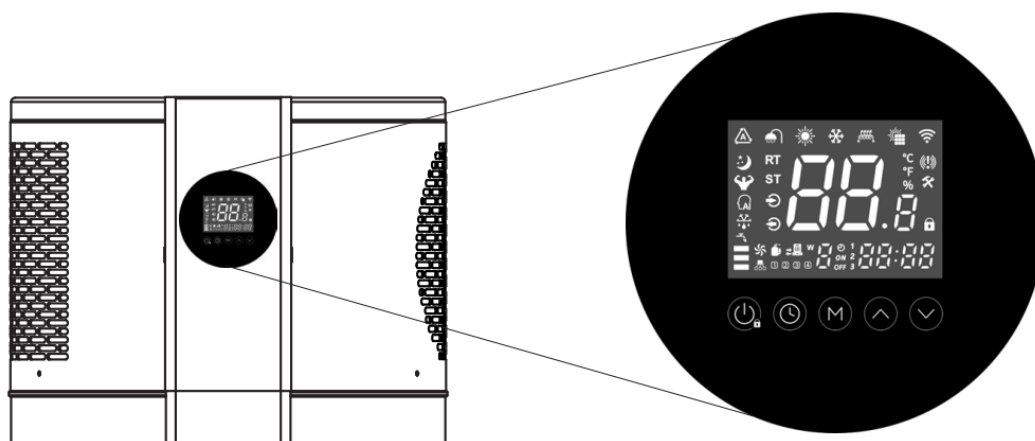



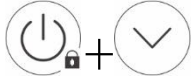
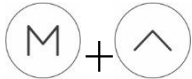
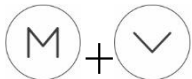
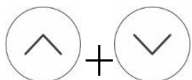

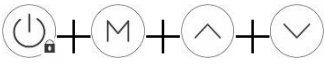
- Display the water temperature and setting temperature, and also can query the coil temperature, ambient temperature and exhaust temperature and so on.
- Power cut memory function.
- When power cut, the clock will still work.
- Timing on/off.
- Automatic defrosting.
- Touch screen
- The error code display and query
- Anti-freezing function
- PV function available

## 7.2. Controller interface display and instruction of icons

























Name	Symbol	Function
On/off key		<ol style="list-style-type: none"> <li>1.On/off key (hold for 1 second)</li> <li>2.Return key</li> <li>3.Escape key</li> <li>4.Unlock key (hold for 5 seconds)</li> </ol>
Clock key		<ol style="list-style-type: none"> <li>1.Setting the clock, press the key will enter into clock setting interface, and then press one time to switch the hour and minute area</li> <li>2.Setting the timer (press the key and hold for 3s)</li> <li>3.During timer setting, press the key and hold for 3s, cancel the current timer setting</li> </ol>
Mode key		<ol style="list-style-type: none"> <li>1.Press the key and hold for 5s, enter into parameter setting interface</li> <li>2.Press the key to change operation mode</li> <li>3.In parameter query interface, press the key enter into value setting or save the setting</li> </ol>
Up key		<ol style="list-style-type: none"> <li>1.Press the key to change temperature setting value or parameter value or change hour and minute value</li> <li>2.Press the key and hold for 3s to query the system status/ parameter</li> <li>3.Page up</li> </ol>
Down key		<ol style="list-style-type: none"> <li>1.Press the key to change temperature setting value or parameter value or change hour and minute value</li> <li>2.Press the key and hold for 3s to query the system status/ parameter</li> <li>3.Page down</li> </ol>
Combination key		Press and hold the two keys for 5s, enter into manual intelligent distribution network connection by manual

		Press and hold the two keys for 5s, enter into manual AP distribution network connection
		When heat pump running in heating mode, press the two keys and hold for 3s, turn ON/OFF Boost mode (turn ON/OFF heating element)
		When heat pump run, press the two keys and hold for 5s, start/exit defrosting mode
		When power on the heat pump, press the two keys and hold for 3s, enter into Ventilation mode, run in high speed, press again, run in low speed, press again, exit Ventilation mode
		Press the three keys and hold for 5s, turn ON/OFF sterilization mode
		Power on within 5 minutes and don't turn on the heat pump, press the four keys and hold for 5s, restore the factory setting

Symbol	Status	Meaning
	Not bright	Heat pump OFF or not in heating mode
	Light up	In heating mode
	Light up	Heating element ON
	Flash for 1s	Run in Boost mode
	Flash for 2s	Run in sterilization mode
	Flash	WIFI distribution network
	Light up	WIFI connect successfully
	Light up	Water temperature



	Light up	Setting temperature
	Light up	degree centigrade
	Light up	degree Fahrenheit (reserved)
	Light up	Percent(reserved)
	Light up	Low/middle/high water level(reserved)
	Flash	Heat pump OFF and refrigerant recovery mode
	Light up	In defrosting mode
	Light up	Maintenance mode
	Light up	There is error
	Light up	Lock screen
	Light up	Compressor running
	Light up	High fan speed
	Light up	Low fan speed
	Flash for 1s	Ventilation mode: high fan speed
	Flash for 2s	Ventilation mode: low fan speed
	Display	Error code display

	Light up	Timer ON
	Display	In timing ON period
	Flash	Setting timing ON
	Display	In timing OFF period
	Flash	Setting timing OFF
	Light up/Not bright	Timer number 1/2/3
	Display	Week

### 7.3. Lock and unlock:

When the controller is in the normal display mode and there is no button operation for more than 60 seconds it will get automatically locked. Press the key "  " for 5 seconds to unlock, it will beep.

### 7.4. Turn ON/OFF the Heat Pump:

When the controller is in the normal display mode, press "  " button for more than 1 second to switch the controller to the power ON or OFF mode.

### 7.5. Water Temperature Set

Unlock the controller, in the main interface, press the "^" or "v" button to increase or decrease the water temperature setting value. **In compliant to Australian law, the heat pump is preset to restore to 55°C every 24 hours, so it is recommended to set the water temperature to 55°C.**

## 7.6. Operation mode selection:

When the controller is in normal display mode, press "M" key to show the existing operation mode, it will display constantly for 8 seconds, before it disappear, press "M" again to switch between different operating modes;

The mode name will show at the clock area for 8 seconds each time when you touch "M" key, when unlock, the area will show clock, pressing "M" key one time will query the existing operation mode.

The system default mode is STAN mode; When the unit is switched on for the first time ,the system will operate under STAN mode, later on the unit will always start as per previous setting mode. For changing the mode, refer below instructions:

### Operation Modes List:

No.	Mode	Symbol
01.	Standard Mode	STAN
02.	Boost Mode	HYBL
03.	Electric Mode	ELE

## 7.7. Clock settings:

In the main interface, click the "  "button to enter the clock setting interface;

In the real-time clock interface, if we press the "  "button, the hour part of the number flashes, press "∧" or "∨", you can set the hour of the clock;

when the hour part is set, press the "  " button again, the number of minutes will flash, press "∧" or "∨" to set the minutes of the clock;

After the minutes part is set, press the "  " button again to confirm the real-time





clock setting and return to the main interface;

In the real-time clock setting interface, if there is no button operation for 60 seconds, the current clock setting value will be confirmed and return to the main interface;

In the clock setting interface, press the "  " button to confirm the clock setting value and return to the main interface.

#### 7.8. Work Time Settings:

Press and hold the "  " button for 3 seconds in the main interface to enable or disable the timer working mode. Then press "Λ" or "V" to chose the timer NO. 1 or No.2 or No.3 period.

When the timer No. 1 period is selected, the symbol flashes, press and release "  " to switch the hour of the start time, the hour part of the number flashes, press "Λ" or "V", you can set the hour. When the hour part is set, press the "  " button again, the number of minutes will flash, press "Λ" or "V" to set the minutes. After the minutes part is set, press the "  " button again set the hour of the end time, the hour part of the number flashes, press "Λ" or "V", you can set the hour. When the hour part is set, press the "  " button again, the number of minutes will flash, press "Λ" or "V" to set the minutes.

After the minutes part is set, press the "  " button again to confirm the setting and then switch to next period timer working set, the setting method is the same as above.

If the start time of a certain working period is greater than the end time, the end time is considered to be of the next day.



When all time periods are canceled, it is considered to be in working hours throughout the day.

When the start time and end time of a certain working period are the same, it discards the time period.

#### 7.9. Forced defrosting:

When the controller is in the normal display mode and the heat pump is ON. Press "M" and "V" buttons together for more than 5 seconds to activate or deactivate the "Forced Defrost" function. The symbol "  " will light up when the "Forced Defrost" is ON.

#### 7.10. Boost Mode:

When the controller is in the normal display mode and the heat pump in heating mode. Press "  " and "Λ" buttons together for more than 3 seconds to enable or disable the boost mode, when enable the boost mode, heat pump unit and heating element all run, the symbol "  " will flash for 1 second then light up, when the temperature reach at the set temperature, heating element off, the symbol "  " will flash, means it is operate in boost mode.

When turn off the heat pump, will exit boost mode.

### 7.11. Trouble Shooting:

Error code	Error Description	Possible Causes	Solution
E05	Reeferigerant system high pressure protection	High pressure switch is broken/Connection is loose	<b>Contact Customer Care</b>
E09	Communication failure	Signal wire connection loose/There is Strong magnetic field/PCB is broken/Signal wire is broken	
E12	Exhaust temperature too high	Lack of refrigerant/Fluorine system leak	
E15	Tank temperature sensor failure	Sensor failure/Connection is loose	
E16	Coil temperature sensor failure	Sensor failure/Connection is loose	
E18	Exhaust temperature sensor failure	Sensor failure/Connection is loose	
E21	Ambient temperature sensor failure	Sensor failure/Connection is loose	
E29	Suction temperature sensor failure	Sensor failure/Connection is loose	

### 7.12. Operation Parameter Query:

When power on, press "Λ" or "V" button for 3 seconds, will enter into status query interface, press "Λ" or "V" button to query each status; Press "" button will exit status query interface.

No.	Name	Note
04	EEV open	Measured value
05	Coil temp.	Measured value
06	Ambient temp.	Measured value
07	Suction temp.	Measured value
08	Exhaust temp.	Measured value
09	Water Inlet temp.(Water tank)	Measured value

# 8. Commissioning

## Commissioning Check List

### 8.1. System Location

- a. The location where the base of the water heater is located is sufficiently compacted
- b. To avoid subsidence when the system is filled with water.
- c. Enough room has been allowed for service and maintenance of the water heater.
- d. The system has been installed in a location that allows enough ventilation.
- e. The location is free from any corrosive materials or chemicals.
- f. The location is free from any excessive dust or material that can become airborne.

### 8.2. Water System Piping

- a. Temperature and pressure relief valve (PTR valve) is properly installed with a discharge pipe plumbed to suitable discernable discharge point.
- b. Check that all plumbing connections including piping, valves and fittings are properly installed and free of leaks.
- c. The system is completely filled with water and all air is drained from the tank and piping.
- d. The tempering valve has been installed per manufacturer's instructions and the output water temperature is in the range required by local authorities.
- e. The condensate drain line is installed and plumbed to suitable drain point.
- f. All hot water lines are appropriately insulated and protected from UV degradation.

### 8.3. Electrical Connections

- a. The water heater is connected to a supply that has a voltage between 220 - 240 VAC.
- b. All hard wiring complies with all local applicable codes and the requirements of this guide.
- c. The water heater and electrical supply are properly grounded.
- d. A correctly sized overload protection device has been installed.

# 9. Maintenance and Solution

## 9.1. Draining and flushing the system

The system must be completely drained of water before any plumbing work is commenced. This will prevent damage to the storage tank in the event of a vacuum or excessive pressure forming at the storage tank.

The heat pump hot water system should be drained and flushed every five years during a major service of the unit.

- a. Turn off and isolate the power supply to the electrical element.
- b. Turn off the water supply to the water heater.
- c. Release excess pressure from the tank by manually opening the pressure & temperature relief valve. away from the tank.
- d. Manually open the pressure & temperature relief valve which will allow air into the tank and the water within the tank will flow out via the flexible drain pipe

## 9.2. Relief valves

The lever on the relief valves should be operated at least every six months. Failure to do so may result in failure of the tank. If water does not discharge freely from the valves they should be checked and possibly replaced. The relief valves and relief valve drain lines must not be blocked. Some water may discharge during each heating cycle

Every five year's all safety valves should be replaced to ensure continued life and operational safety of the system. In location where the portable water has a Total Dissolved Solids (TDS) of greater than 600 ppm it is recommended to replace all safety valves every 3 years.



### 9.3. Anode replacement

The high quality vitreous enamel lined low carbon steel tanks have a sacrificial anode for long tank life. This anode should be inspected every couple of years and be replaced when it has worn out. As a minimum it is recommended that the anode be changed every 5 years.

### 9.4. Condensate discharge pipe

Check the pipe regularly for cleanliness. Any obstruction may cause poor condensate flow or cause the accumulation of water in the heat pump plastic base.

### 9.5. Cleaning the evaporator

The evaporator is integral to the optimum performance of the appliance.

It is recommended to clean the evaporator fins once every year using a soft-haired brush. If any of the fins are bent, carefully realign then using a suitable comb.

### 9.6. Hydraulic circuit

Check the watertightness of all connections and pipes for signs of any water leaks.

**WIFI CONNECT** Connect your heat pump via the TUYA SMART HOME APP.

1. Make sure the system is powered off (control screen is blank)
2. Download the TUYA SMART HOME APP



3. Turn controller on and make sure it is unlocked and the **WIFI** symbol is flashing.



4. Click Add Device on the TUYA SMART APP
5. Select LARGE HOME APPLIANCES
6. Select SMART HEAT PUMP (WI FI)
7. Select your WIFI NETWORK & ENTER YOUR PASSWORD
8. CONFIRM THE WIFI SYMBOL IS FLASHING FAST
9. Wait for the App to connect.

**Once connected the WIFI SYMBOL will remain solid.**

# 10. Warranty

When proof of installation date is not provided, the start date of the warranty will commence from the system date of manufacture determined by the systems unique serial identifier. It is recommended that homeowners keep receipts, invoices, warranties, and any installation record forms where applicable, in a safe place.

## 10.1. Component Warranty Table

<b>Component</b>	<b>Warranty Period (Parts Only)</b>	<b>Warranty Period (Parts and Labour)</b>
Glass Lined Tank	5 years	
Refrigeration	5 years	
Electrical (controller and sensor leads)	3 years	
Sacrificial Anode & PTR valve	1 year	
Consumable Items	1 year	

## 10.2. Eligibility requirements to make a claim

- The person(s) making the claim must be the product owner or have consent to act on behalf of the owner.
- The person(s) making the claim must contact EFFICIENCY distributor as soon as they notice any defect(s) without excessive delay, and the product must be within its warranty period.
- The product must have its original serial numbers and/ or rating labels where

applicable.

- The warranty period begins from the date of installation of the component(s), in the event that proof of installation cannot be provided, the period begins from date of purchase, and in the event that this is also not available, the warranty will begin from date of manufacture of the product

### 10.3. General warranty conditions

10.3.1. This Warranty is for domestic & residential use of the hot water heating system only. Any application with hot water consumption above 700 L/day is considered NON-residential. Domestic is defined per below:

- a. Units installed in any domestic dwelling.
- b. Hot water consumption below 700 Liters per day.

10.3.2. To the extent that a claim falls under the 'Parts Only' Warranty Period, the Warranty covers the repair and/or replacement of such failed component in domestic use free of charge. However, the transport, installation and labor costs of repairing the component or delivering the replacement component and removing and replacing the existing component will be the responsibility of the customer of the existing component.

10.3.3. To the extent that a claim falls under the 'Parts and Labor' Warranty Period, the Warranty covers the repair and/or replacement of such failed component in domestic use and any associated labor costs free of charge.

Please note the cost of freight may be charged to the customer.

10.3.4 EFFICIENCY reserves the right to alter the design, components or construction to its domestic hot water system or custom design. Such alterations shall not constitute a defect in design or construction under this Warranty.

10.3.5. Any claim under this Warranty must include full details of the defect and/or damage to the hot water system or component(s) in domestic use. All claims must be made within one (1) month of the detection of the defect.

10.3.6. To the extent permitted by law, EFFICIENCY shall not be liable under this Warranty for any consequential loss or damage or any incidental expenses resulting from any breach of this warranty, including but not limited to, claims for damage to buildings, roofs, ceilings, walls, foundations, gardens, personal belonging or household effects, fixtures and fittings, or any other consequential loss, damage or inconvenience, either directly or indirectly due to leakage from the hot water system or component(s) in domestic use or any other matter related to the system or its operation.

10.3.7. The benefits conferred by this Warranty are in addition to all other rights and remedies in respect of the hot water system or component(s) in domestic use, which the purchaser has under the Competition and Consumer Act 2010 and consumer protection legislation of the States and Territories. Nothing in this Warranty has the effect of excluding, restricting or modifying those rights.

10.3.8. Goods presented for repair may be replaced by refurbished goods of same type rather than being repaired. Refurbished parts may be used to repair/replace the goods.

10.3.9. If the Customer has not paid in full for the hot water system or component(s), then this Warranty does not apply (Proof of purchase is a MUST).

#### 10.4. Heat pump warranty conditions

10.4.1. All heat pump hot water system must be installed by a licensed installer.

10.4.2. Only a licensed professional must Install, Commission or Service the hot water system.

10.4.3. All the hot water system must be installed in accordance with Manufacturer's Installation Instructions and in Accordance with local regulations, municipal building codes and current AS/NZS 3000, AS/NZS 3500, AS 3498 and AS/NZS 5601

10.4.4. If the hot water system has not been installed in accordance with Manufacturer's Installation Instructions or installed as to be easily accessible for servicing, a service charge may apply.

- a. The integration with tank and controller should follow the instructions in the installation manual.
- b. The operational conditions should not exceed from those specified in the installation manual (i.e. -10 to 43 °C).
- c. The storage tank MUST have a 850 kPa PTR valve installed, while the main cold pressure to the hot water system is limited by a 500 kPa PLV.
- d. Electricity supply to the heat pump unit must be accordance with the relevant Australian standards as well as guidelines in the installation manual (i.e. 240V supply and 15A circuit breaker).

10.4.5. Water quality must be within limits specified below table.

Total Dissolved Solids	< 600 mg/L or ppm
Total Hardness (CaCO <sub>3</sub> )	< 200 mg/L or ppm
Electrical Conductivity	850 μS/cm
Chloride	< 300 mg/L or ppm
pH Level	Min 6.5 to Max. 8.5
Magnesium	< 10 mg/L or ppm
Sodium	< 150 mg/L or ppm
Iron	< 1mg/L or ppm
Alkalinity (as CaCO <sub>3</sub> )	< 200 mg/L or ppm
Dissolved (free) CO <sub>2</sub>	< 25 mg/L or ppm



## 10.5. WARRANTY FORM

Please complete details and retain this warranty together with your purchase invoice and plumbing certificate, which must be presented when making a warranty claim.

Home Owner Name:

Street Number and Name:

Suburb, State, Postcode:

Owner contact phone no:

Owner Email:

Date of Installation:

Product detail and Model No:

Heat pump Serial Number:

Supplier Name:

Plumber Name:

Plumber contact details:

This warranty does not exclude, limit or modify any warranty, condition or liability which is or may be implied or imposed on the Company by virtue of the Trade Practices Act, 1974, or any other statute, law, rule or regulation except for the extent to which the Company is lawfully entitled. Note that EFFICIENCY is not liable for any expenses associated with making a warranty claim.